

COOPERATIVA FALEGNAMERIE ASSOCIATE

via ai Closs - cp 155
6593 Cadenazzo

tel. 091 858 00 69
fax 091 858 00 70

info@usfa.ch - www.usfa.ch



PRODOTTO:

porta interna legno - RUBNER
tagliafuoco EI30

DESCRIZIONE:
sez. orizz.

CANTIERE:

XXX XXX

N° D'ORDINE:

XXX

FORMATO:

A4

DISEGNATORE:

SR

ULTIMA MODIFICA:

20.05.09

SCALA:

1:1

TAVOLA:

006 - R.EI30

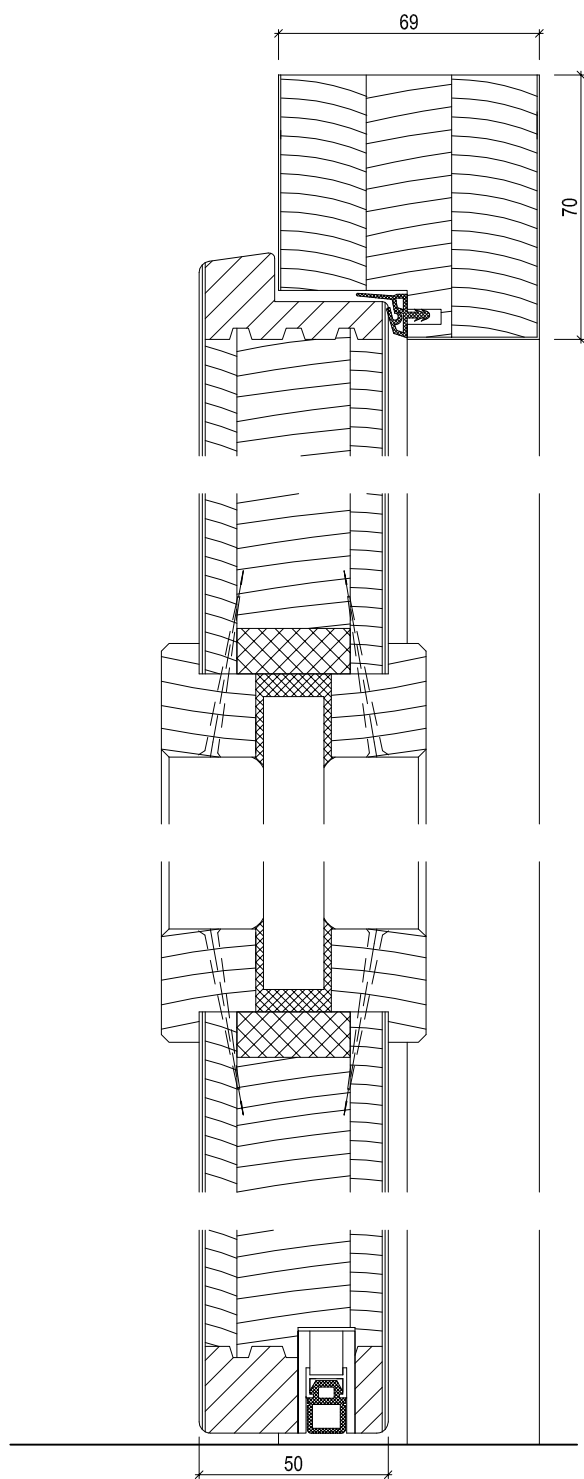

COOPERATIVA FALEGNAMERIE ASSOCIATE

via ai Closs - cp 155
6593 Cadenazzo

tel. 091 858 00 69
fax 091 858 00 70

info@usfa.ch - www.usfa.ch



PRODOTTO:

porta interna legno - RUBNER
tagliafuoco

DESCRIZIONE:

dett. anta 44mm / normale

CANTIERE:

XXX XXX

N° D'ORDINE:

XXX

FORMATO:

A4

DISEGNATORE:

SR

ULTIMA MODIFICA:

07.04.09

SCALA:

1:2

TAVOLA:

005 - R.EI30

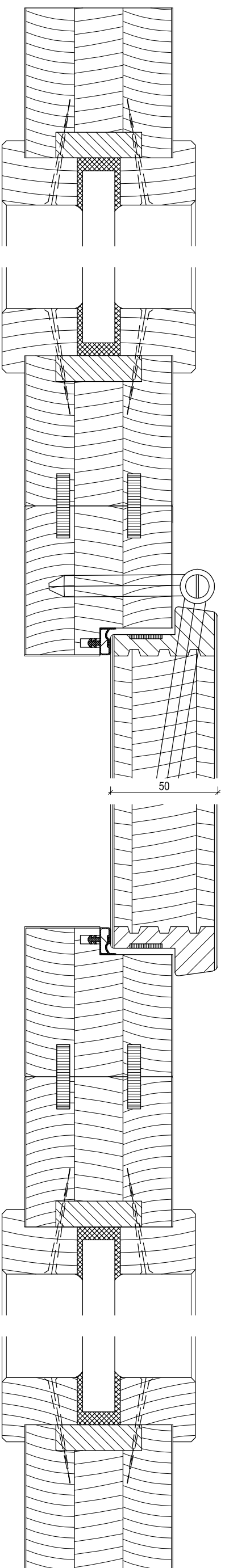

| | | | |
|--|----------------|---|--|
| COOPERATIVA FALEGNAMERIE ASSOCIATE via al Closs - cp 155 6593 Cadenazzo tel. 091 858 00 69 fax 091 858 00 70 info@usfa.ch - www.usfa.ch | | | |
| CANTIERE: XXX XXX | | PRODOTTO: porta interna legno - RUBNER tagliafuoco EI30 | |
| N° D'ORDINE: XXX | FORMATO: A3 | DISEGNATORE: XXX | |
| ULTIMA MODIFICA: 07.04.09 | SCALA: 1:2 | TAVOLA: 004 - R.EI30 | |
| DESCRIZIONE: sez. orizz. | | | |

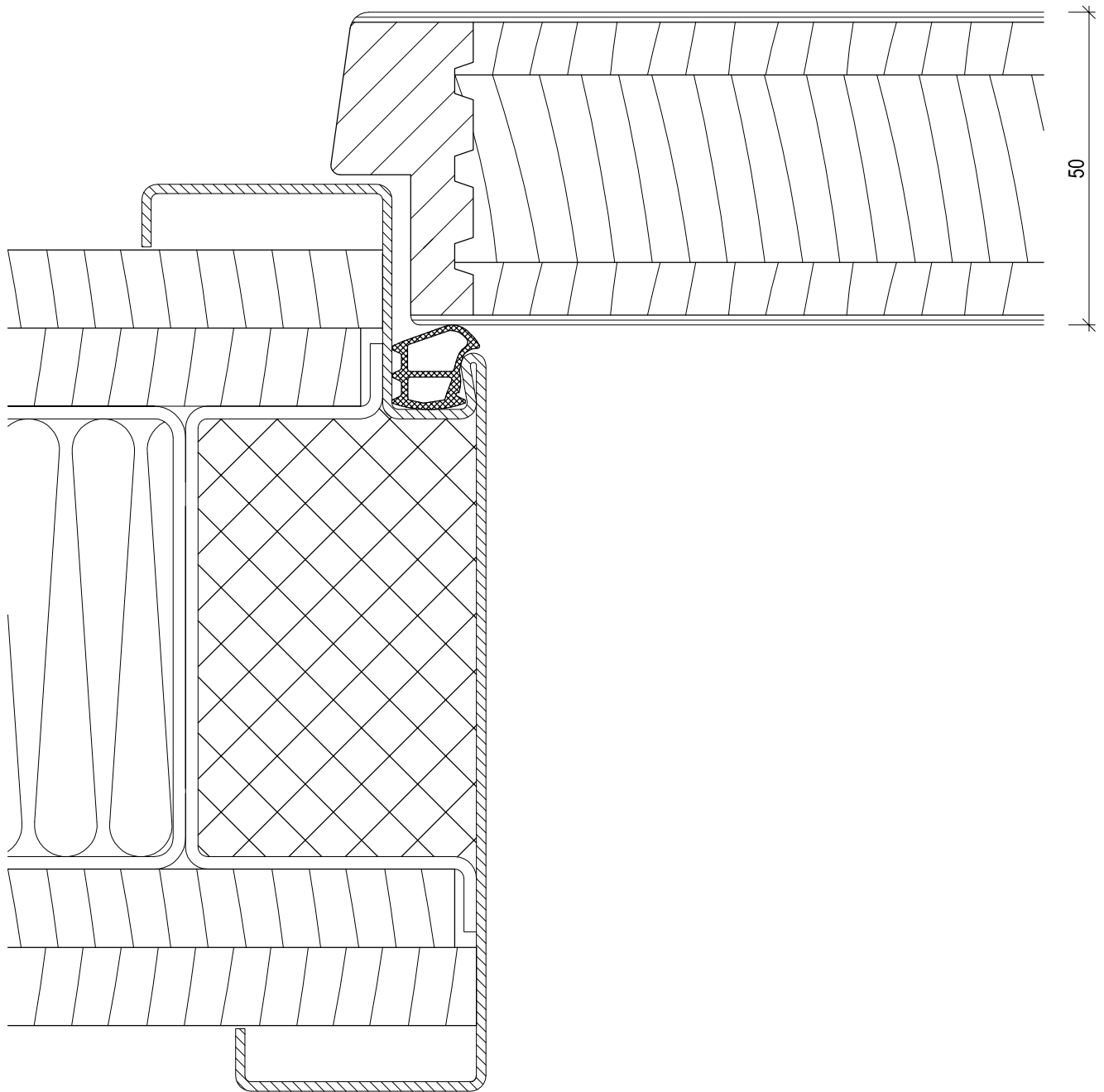

COOPERATIVA FALEGNAMERIE ASSOCIATE

via ai Closs - cp 155
6593 Cadenazzo

tel. 091 858 00 69
fax 091 858 00 70

info@usfa.ch - www.usfa.ch



PRODOTTO:

porta interna alu - RUBNER
tagliafuoco EI30

DESCRIZIONE:
sez. orizz.

CANTIERE:

XXX XXX

N° D'ORDINE:

XXX

FORMATO:

A4

DISEGNATORE:

XXX

ULTIMA MODIFICA:

20.05.09

SCALA:

1:1

TAVOLA:

003.1 - R.EI30



info@usfa.ch - www.usfa.ch

COOPERATIVA FALEGNAMERIE ASSOCIATE

via ai Closs - qp 155

6593 Cadenazzo

tel. 091 858 00 69

fax 091 858 00 70

PRODOTTO:

porta interna legno - RUBNER
tagliafuoco EI30

DESCRIZIONE:

sez. verticale

CANTIERE:

XXX XXX

N° D'ORDINE:

12.01.09

ULTIMA MODIFICA:

07.04.09

FORMATO:

A4

SCALA:

1:5

DISEGNATORE:

SR

TAVOLA:

002 - REI30

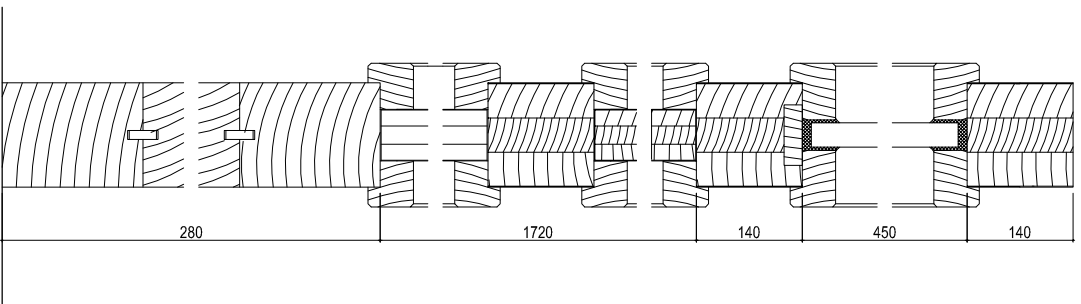
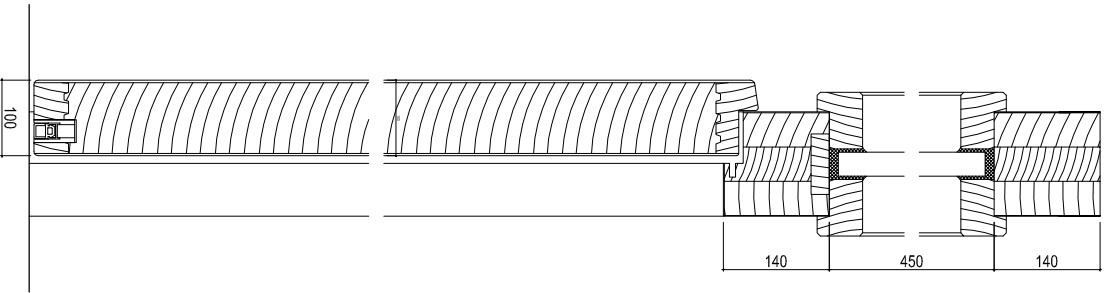
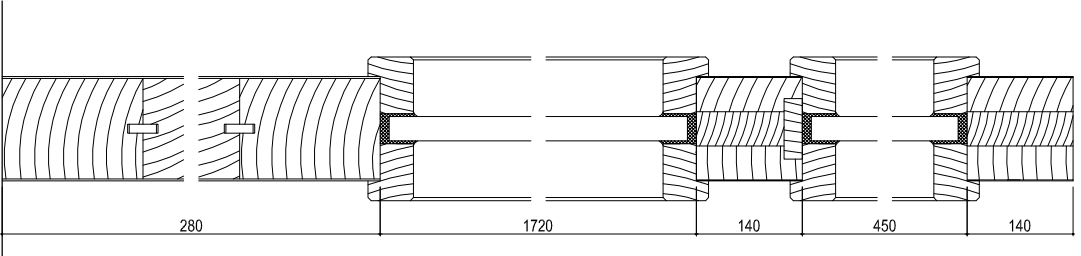

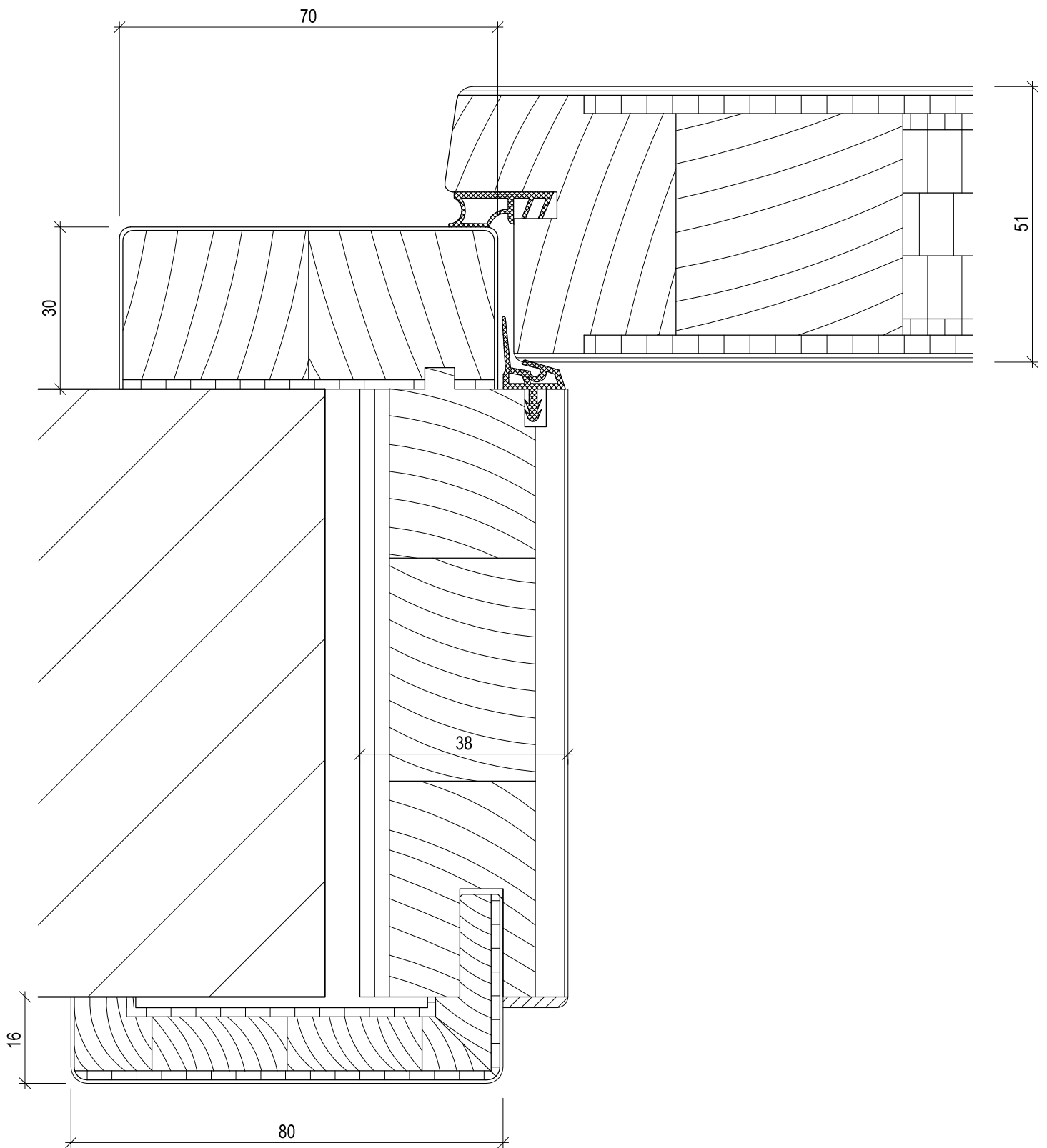

COOPERATIVA FALEGNAMERIE ASSOCIATE

via ai Closs - cp 155
6593 Cadenazzo

tel. 091 858 00 69
fax 091 858 00 70

info@usfa.ch - www.usfa.ch



PRODOTTO:

porta interna legno - RUBNER
telaio a cassetta / tagliafuoco EI30

DESCRIZIONE:

dett. anta 51mm / normale

CANTIERE:

XXX XXX

N° D'ORDINE:

XXX

FORMATO:

A4

DISEGNATORE:

SR

ULTIMA MODIFICA:

07.04.09

SCALA:

1:1

TAVOLA:

001 - R.EI30

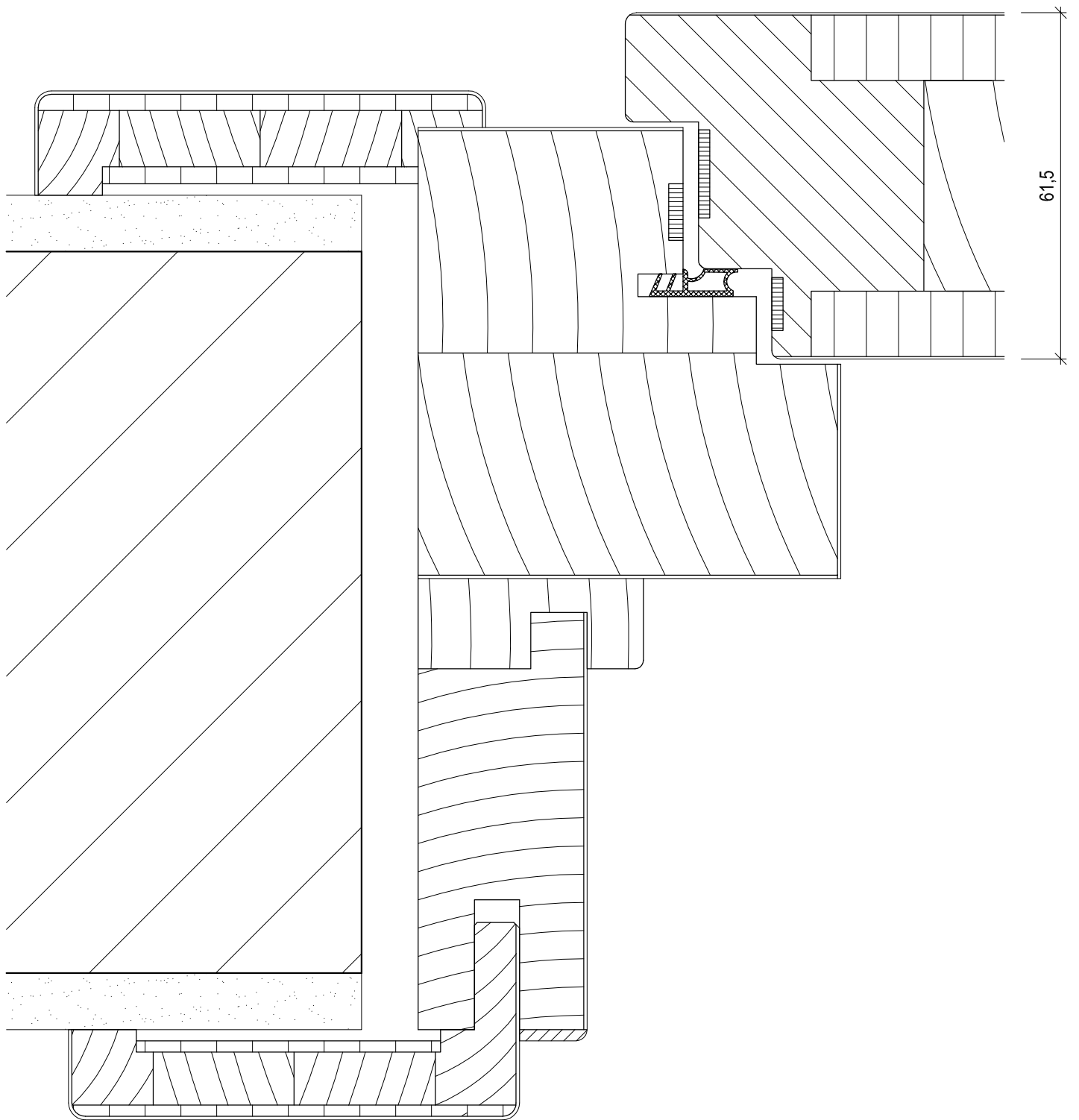

COOPERATIVA FALEGNAMERIE ASSOCIATE

via ai Closs - cp 155
6593 Cadenazzo

tel. 091 858 00 69
fax 091 858 00 70

info@usfa.ch - www.usfa.ch



PRODOTTO:

port. legno - RUBNER
telaio a cassetta / tagliafuoco EI30

DESCRIZIONE:

dett. anta 44mm / normale

CANTIERE:

XXX XXX

N° D'ORDINE:

XXX

FORMATO:

A4

DISEGNATORE:

SR

ULTIMA MODIFICA:

19.01.09

SCALA:

1:1

TAVOLA:

009 - R.EI30

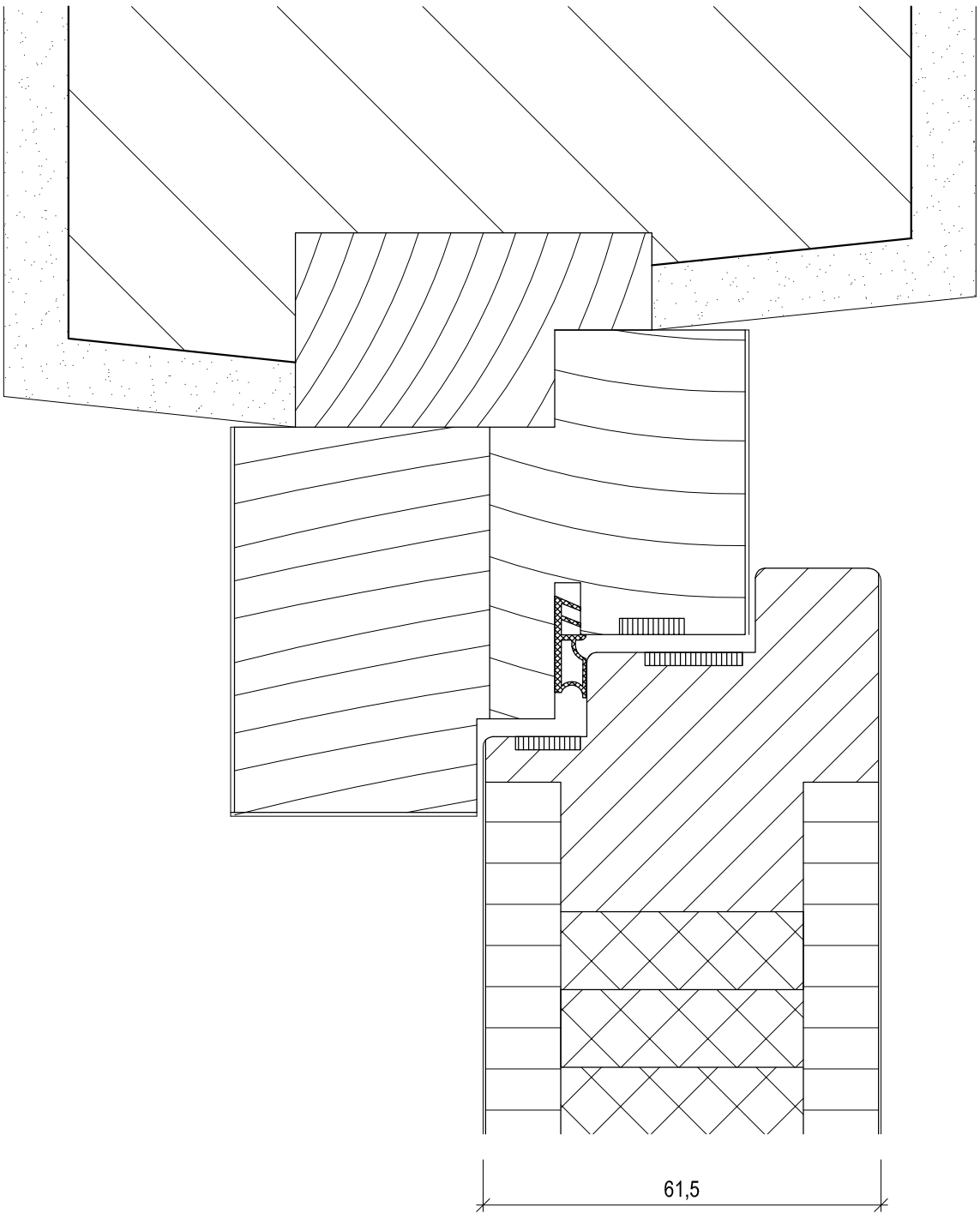

COOPERATIVA FALEGNAMERIE ASSOCIATE



via ai Ciassi - qp 155
 6593 Cadenazzo
 tel. 091 858 00 69
 fax 091 858 00 70
 info@usfa.ch - www.usfa.ch

PRODOTTO:

porta interna - RUBNER
 telaio applicato / tagliafuoco EI30

CANTIERE:

XXX XXX

N° D'ORDINE:

XXX

FORMATO:

A4

DISEGNATORE:

SR

ULTIMA MODIFICA:

20.05.09

SCALA:

1:1

TAVOLA:

010.1 - REI30